

DACIA

# DACIA DUSTER



3rd October 2023



1

## EXPLORE YOUR DUSTER

DISCOVER



2

## YOUR DUSTER FOR DAILY USE

DISCOVER



3

## EQUIPMENT AND TECHNICAL CHARACTERISTICS

DISCOVER



4

## THE DACIA SPIRIT: GOOD THINKING

DISCOVER





# THE AUTHENTIC SUV





# SIMPLY RUGGED

Nothing can stop it. Now, more than ever, Dacia Duster is the archetypal SUV. Its iconic style, assertive design and new body-tone colours enhance its adventurous character. Today, Duster is available in the Extreme finish, which adds the exclusive Cedar Green colour to its palette for an even more off-road look.





# EXTREME, A LOOK MORE DUSTER THAN EVER

Dacia Duster Extreme is instantly recognisable thanks to the attention given to the finishes. Inside, screen-printed door sills and floor mats welcome you on board. As for the shimmer provided by the Copper Brown finishes, it embellishes the air vents and the base of the gear lever, the front door topstitching, the central armrest and the handbrake. Finally, the washable mixed MicroCloud plasticcoated fabric upholstery is designed to cope with any type of adventure.



On the outside, Copper Brown details can be found on the mirrors, identity marking on the sides, modular roof bars and rear tailgate. It exudes a thirst for adventure with its glossy black alloy wheels decorated with Copper Brown centre caps, its wheel arch mouldings and its shark fin antenna.



**COPPER BROWN DOOR MIRROR SHELLS**



**GLOSSY BLACK ALLOY WHEELS WITH  
COPPER BROWN CENTRE CAPS**



**COPPER BROWN DACIA LOGO ON THE TAILGATE**





## OVERCOME OBSTACLES

Feel free: Dacia Duster takes you wherever you want to go with complete peace of mind.

With its robust chassis, high ground clearance and off-road capabilities (in the 4-wheel drive version), it makes light work of rough terrain and uneven surfaces. Hill Start Assist allows you to tackle the steepest of slopes; adaptive Hill Descent Control\* prevents skidding by controlling the speed of your SUV.

The 4x4 Monitor feature with built-in compass and altimeter makes sure you always have the right information at the right time. Adjust the knob\*, switch from traction to four-wheel drive and enjoy your adventure playground!

\* On 4x4 versions.



### REAL OFF-ROAD CAPABILITIES

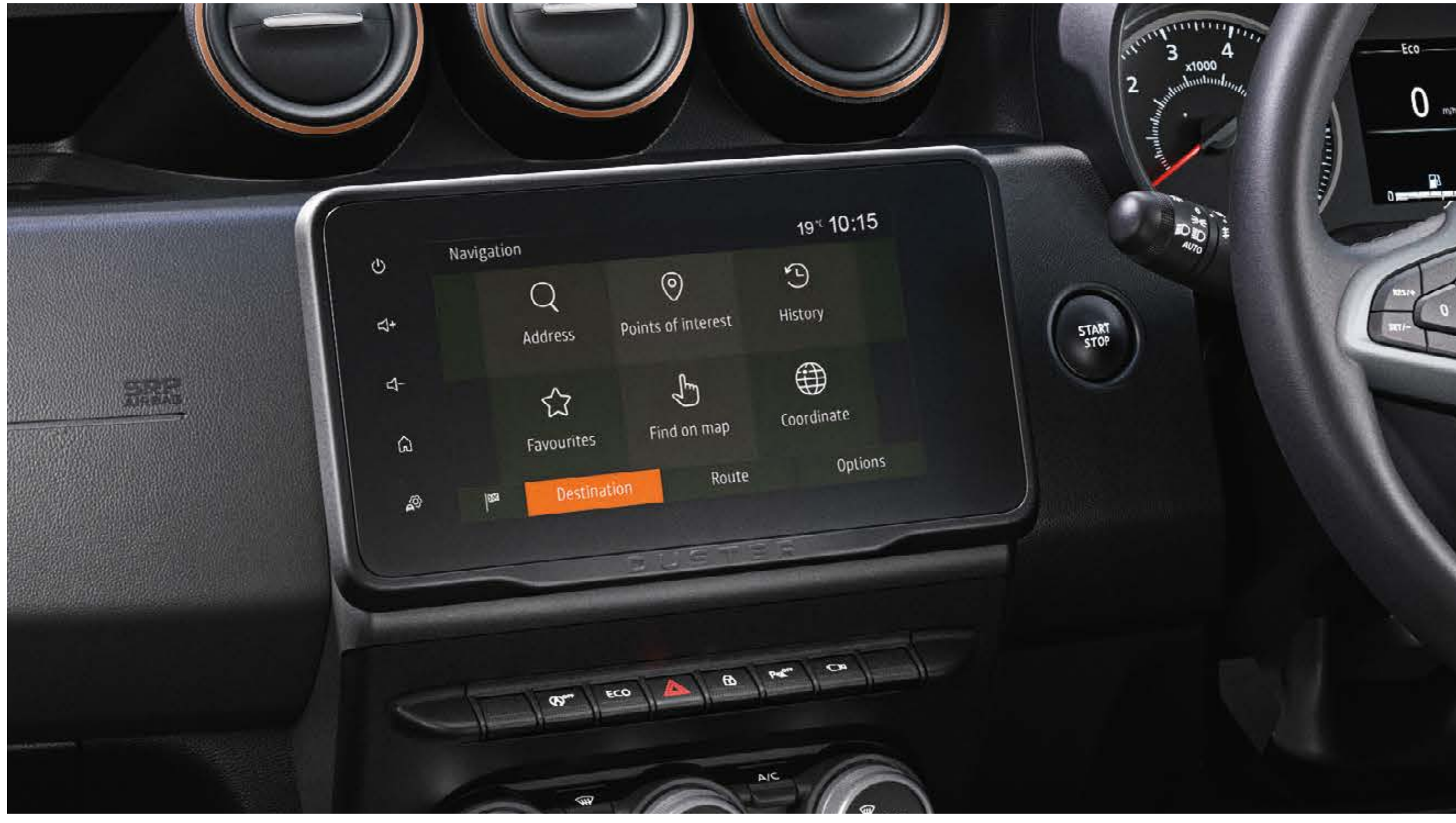

### COMPASS AND ALTIMETER



### 4X4 KNOB

[BUILD YOURS](#)

[MENU](#)



# URBAN ADVENTURER

Because adventure begins at the corner of your street, Dacia Duster is just as at home in the city. With its electrical power-assisted steering, blind spot warning and brand-new EDC automatic gearbox,<sup>(1)</sup> driving has never been so smooth. And on the engine front, Duster offers a real choice: diesel, petrol or bi-fuel (petrol and LPG).

(1) Available with the TCe 150 engine.





# A FULLY-EQUIPPED PASSENGER COMPARTMENT

Inside, comfort is also on the agenda with the sliding centre console offering additional storage space (almost 1.1 L). On the steering wheel, the backlit buttons are easier to identify. The dashboard accommodates a large 8-inch, semi-flush touch screen, as well as two USB ports.



Two multimedia systems are now available to meet all individual needs: Media Display and its intuitive, user-friendly interface feature an 8-inch screen, four speakers, Bluetooth® connectivity and smartphone replication with Android Auto™ and Apple CarPlay™.

Media Nav, meanwhile, comes with MAP CARE on-board navigation (Western or Eastern Europe maps + 6 free updates for 3 years on-board) and two additional speakers. In the back, passengers have two USB\* sockets for charging tablets and smartphones. Peace of mind on long journeys!

Android Auto™ is a trademark of Google Inc.

Apple CarPlay™ is a trademark of Apple Inc.

\* Depending on version.



**SMARTPHONE MIRRORING VIA USB CABLE**





## BOOT SPACE AND FULL OF IDEAS

You won't believe what you can take with you in Duster. So don't hold back! Luggage, parcels, furniture... your SUV is always ready. The extremely modular layout lets you adapt the passenger compartment to your needs or desires: the loading capacity of the boot, the flexibility in using the interior space (60/40 split fold rear bench seat, but all of the seats can be folded down) maximise your carrying options.

The many storage spaces in the doors and on the backs of the front seats invite you to empty your pockets and enjoy freedom while driving!



**418 LITRES OF BOOT VOLUME**



**FOLDING REAR BENCH SEAT**



# DRIVE IN COMPLETE SAFETY



True adventurers prioritise safety. Dacia Duster is no exception to this rule, comprising features that let you drive with complete peace of mind, wherever you choose to go. A reinforced body structure, front and side airbags and the Isofix child seat mounting system make sure that everyone is protected.



## MULTIVIEW CAMERA

The MultiView Camera gives you more eyes! It provides front, rear and side views, helping you detect holes, rocks or obstacles that are not always easy to see, and making driving easier for you.



## HILL DESCENT CONTROL

Hill Descent Control maintains a constant speed that is adaptable between 5 km/h and 30 km/h in «Lock» mode to prevent skidding in the 4x4 version.



## AUTOMATIC WINDSCREEN WIPERS

The rain sensor at the top of the windscreen automatically activates the wipers.

[BUILD YOURS](#)

[MENU](#)



# DISCOVER THE EQUIPMENT

COLOURS



AMBIANCES



ACCESSORIES



ENGINES



EQUIPMENT & OPTIONS



PRICING



SERVICING



DIMENSIONS





# COLOURS

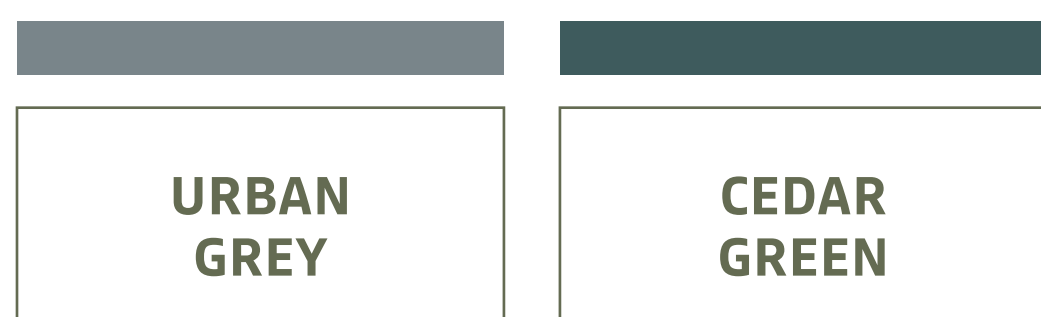

DUSTY KHAKI<sup>(3)</sup>



ARIZONA ORANGE<sup>(2)\*</sup>



GLACIER WHITE<sup>(1)</sup>



SLATE GREY<sup>(2)</sup>



PEARL BLACK<sup>(2)</sup>



URBAN GREY<sup>(3)</sup>



CEDAR GREEN<sup>(2)\*\*</sup>

(1) Solid paint. (2) Metallic paint. (3) Special paint.  
\*not available on Extreme.  
\*\* only available on Extreme.  
Non-binding photos.



# AMBIANCES

## ESSENTIAL



## MAIN EQUIPMENT

### EQUIPMENT

- 6 airbags (front, shoulders, curtains)
- ABS and emergency brake assist
- Automatic headlights
- Luggage cover
- Remote central locking
- Electric variable power steering
- Eco Mode, Stop & Start and gearshift indicator
- ESC and hill start assist
- Storage spaces in rear doors
- Isofix anchorage for lateral rear seats
- Inflation kit
- Electric front windows
- Speed limiter and cruise control with steering wheel controls
- Front central ceiling light
- 12 V socket in front
- Manual adjustable door mirrors
- Eco-LED headlights
- Split and folding rear bench seat 1/3-2/3
- Dacia Plug & Music (DAB radio, jack and USB sockets, Bluetooth® phone connectivity with steering wheel-mounted controls)
- 4 speakers

- Height- and reach-adjustable steering wheel
- Soft feel steering wheel
- Manual air conditioning
- Front fog lights
- Rear parking sensors
- 180 kmh / 112 mph Speed Limiter

### DESIGN

- New grille featuring Dacia logo and white decorative inserts
- Body-coloured bumpers
- Steel Grey air vent grilles
- Steel Grey circular air vent surrounds
- 16-inch steel wheels
- Black door handles and exterior mirrors
- Fabric upholstery
- LED daytime running lights
- Black longitudinal roof bars

### OPTIONS

- Spare wheel and jack (not available on TCe100 Bi-Fuel versions)
- Slate Grey metallic paint
- Dusty Khaki special paint



## EXPRESSION



### MAIN EQUIPMENT EXPRESSION = ESSENTIAL +

#### EQUIPMENT

- 2 central front roof lights (driver and passenger)
- Driver's side one-touch electric window
- Rear electric windows
- Seat-back pockets for front seats
- 12 V socket at the rear
- Rear parking sensors
- Reversing camera
- Electric and heated exterior mirrors
- Driver's seat with height adjustment lever
- Soft-feel steering wheel with Steel Grey decorations
- 8" Media Display: DAB radio, smartphone replication via USB cable and WIFI, compatible with Android Auto™ and Apple CarPlay™, Bluetooth® connection, 4 speakers, 8" touch screen, audio streaming and Bluetooth® telephony with controls on the steering wheel

#### DESIGN

- 16" Oraga alloy wheels
- Body-coloured exterior door handles
- Silver-look exterior mirrors
- Steel Grey interior door handles
- Steel Grey circular air vent outlines with white sliders
- Glossy Black gear lever knob
- 'Expression' upholstery

#### OPTIONS

- Spare wheel + jack (except for TCe 100 Bi-Fuel)<sup>(1)</sup>
- Metallic or special paint

(1) The "spare wheel" option replaces the "inflation kit" equipment.  
Android Auto™ is a trademark of Google Inc. Apple CarPlay™ is a trademark of Apple Inc.



## JOURNEY



### MAIN EQUIPMENT JOURNEY = EXPRESSION +

#### EQUIPMENT

- Automatic air conditioning
- Automatic wipers
- Automatically folding exterior mirrors with control pad on driver's door
- Multiview camera
- Media Nav 8": navigation with MAP CARE (Western or Eastern Europe map + 6 free updates over 3 years), DAB radio, smartphone replication via USB cable and wifi compatible with Android Auto™ and Apple CarPlay™, 6 speakers, 8" touchscreen, Bluetooth® audio streaming and telephone controls on steering wheel, 4x4 info<sup>(1)</sup>, Eco-driving coaching
- Driver's seat with lumbar adjustment
- Blind spot warning
- Semi-high center console with sliding TEP armrest and 1.1L storage
- Central ceiling light for rear passengers
- Illuminated glove box
- Modular roof bars
- Heated front seats
- Keyless entry card
- Two USB sockets in the rear

#### DESIGN

- Exterior Look Pack: front and rear skis, roof bars, and exterior mirror covers in Megalith Grey, tinted windows, side windows, and rear hatch
- 17" Tergan alloy wheels
- TEP door panels with stitching
- Front door pull handles in Fog Grey
- "Journey" upholstery
- Fog Grey interior decorative elements with climate controls

#### OPTIONS

- Spare wheel + jack (except for TCe 100 Bi-Fuel)<sup>(2)</sup>
- Metallic or opaque paint

(1) On 4x4 version.

(2) The "spare wheel" option replaces the "inflation kit" equipment.

Android Auto™ is a trademark of Google Inc. Apple CarPlay™ is a trademark of Apple Inc.



## EXTREME



## MAIN EQUIPMENT EXTREME = JOURNEY +

### DESIGN

- 17" black alloy wheels with Dacia emblem and Copper Brown center caps
- Black shark antenna
- Grille with the new Dacia visual identity
- Copper Brown mirror shells, door and side stickers with topographic patterns, Dacia logo on the tailgate
- Plastic wheel arches front and rear
- Modular roof bars with Copper Brown Duster lettering
- Washable TEP MicroCloud mixed upholstery with specific screen printing
- Washable MicroCloud TEP door medallions with Copper Brown stitching
- Copper Brown details on air vents
- Copper Brown stitching on handbrake and central armrest
- Serrated rubber floor mats front and rear
- Screen-printed front door sills

### OPTIONS

- Spare wheel + jack (except TCe 100 Bi-Fuel)
- Metallic & special paint

[BUILD YOURS](#)

[MENU](#)



# ACCESSORY PACKS

## STYLING PACK

£379 inc. fitting

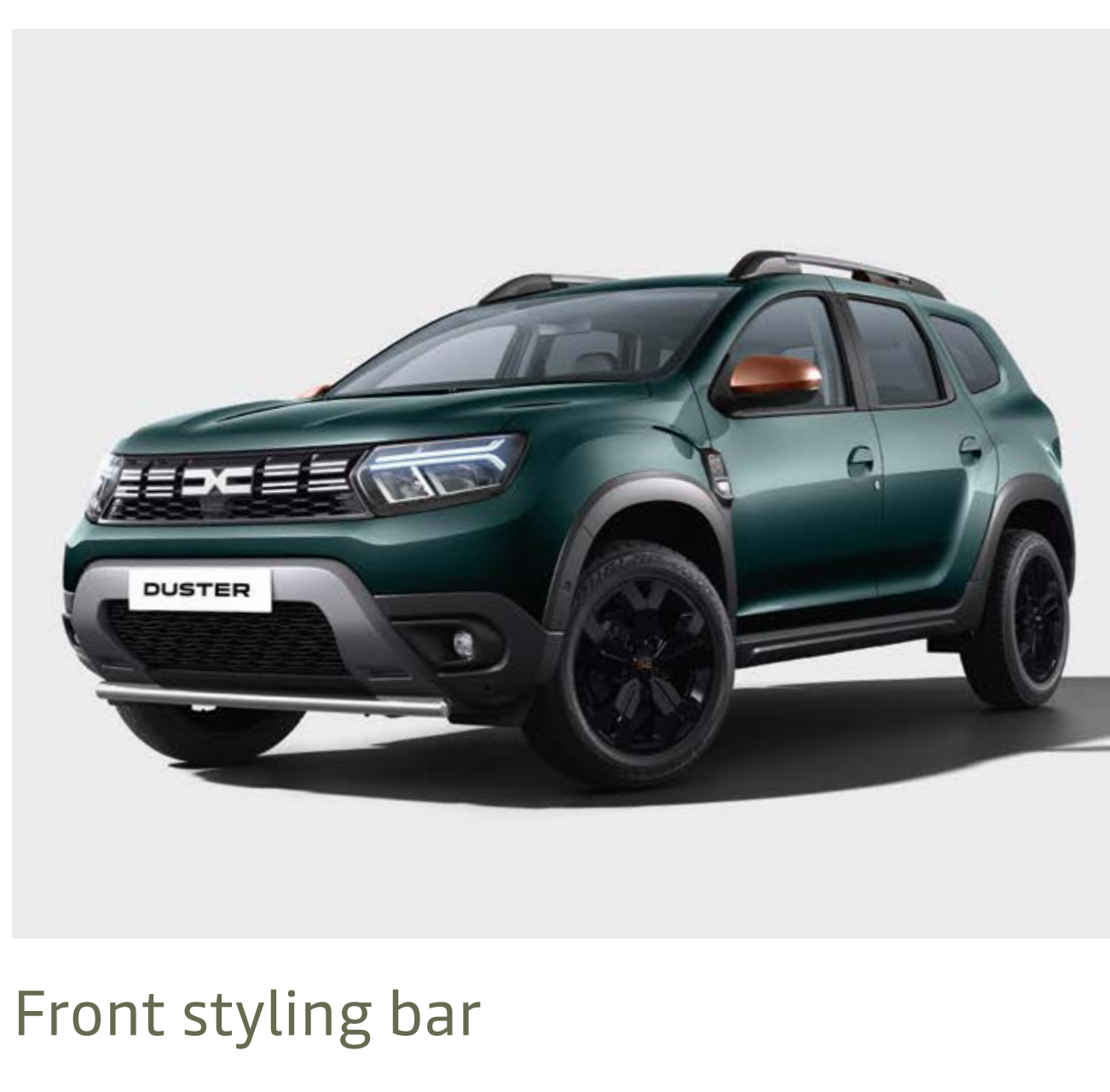

Front styling bar

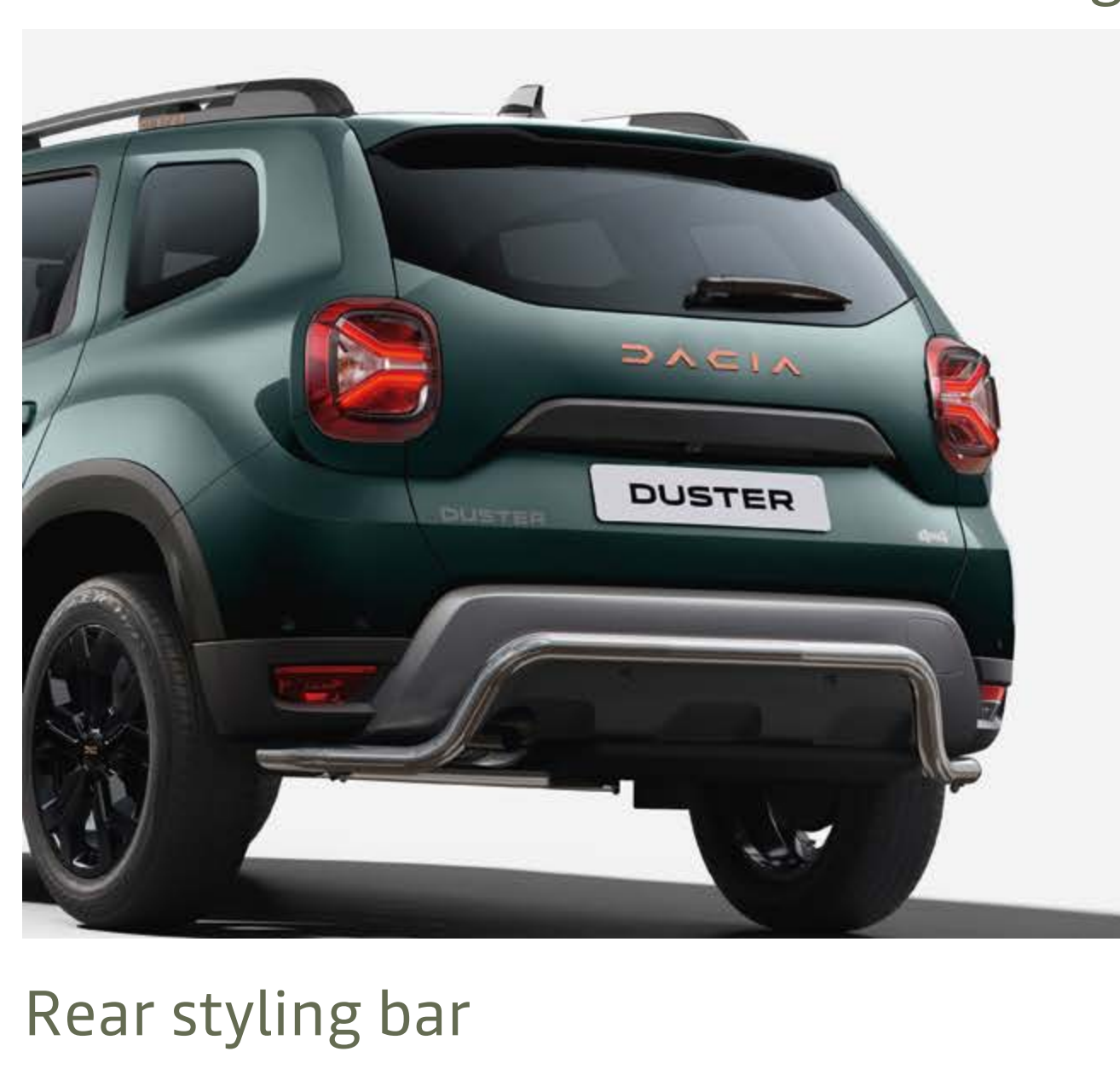

Rear styling bar

## SIDE STEP PACK

£499 inc. fitting



Side steps

## OFF ROAD PACK

£359 inc. fitting



Door sill side protectors & front and rear wing protectors

Available for versions with & without blind spot protection

Not compatible with Extreme versions

## PROTECTION PACK

£305 inc. fitting



Illuminated door sills



Front & rear mud guards



Boot liner

Available in 2WD and 4WD versions

## PET PACK

£205 inc. fitting

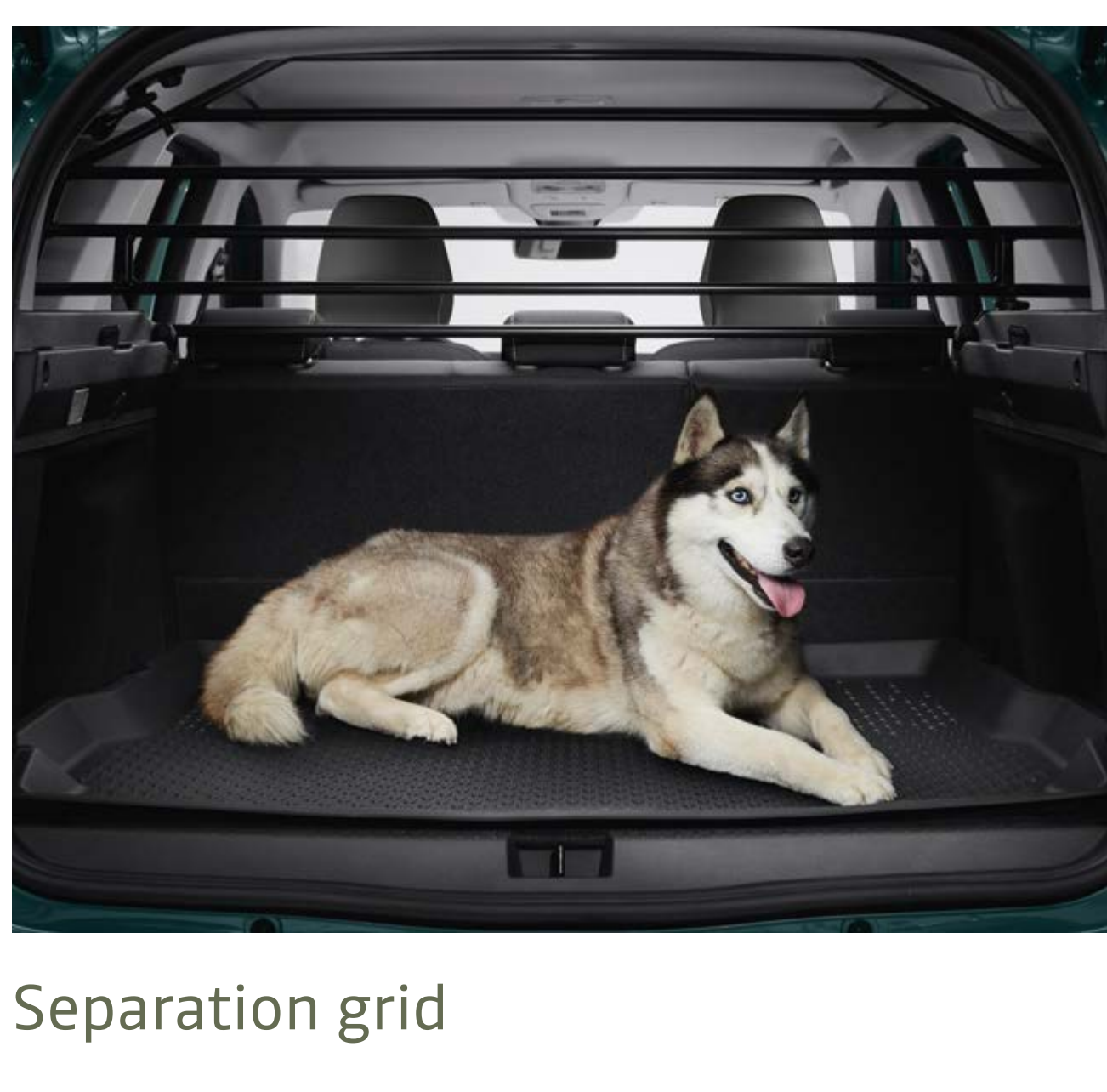

Separation grid

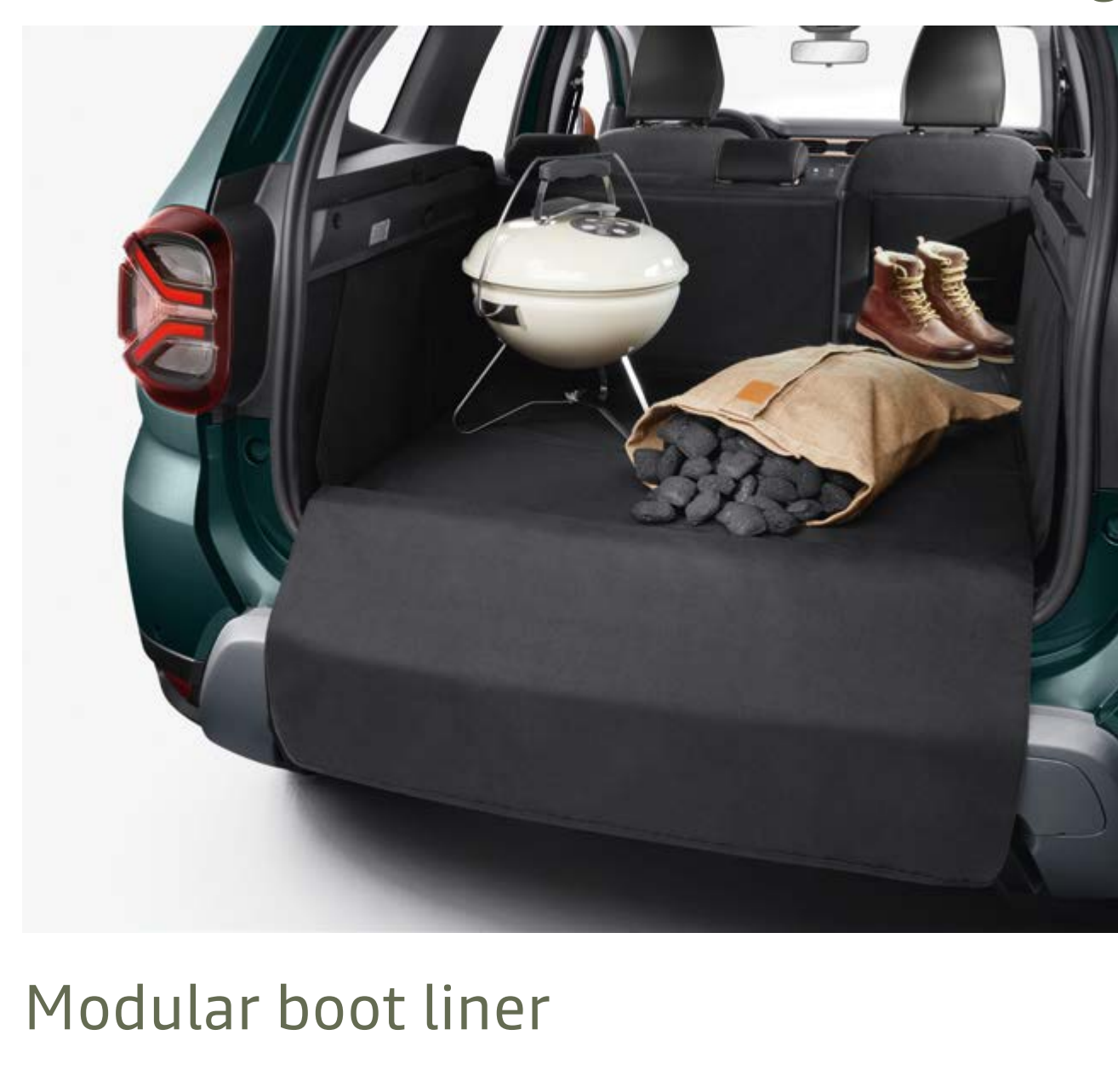

Modular boot liner

## DASH CAM PACK

£422 inc. fitting



KENWOOD front dash cam



KENWOOD rear cam

## TOURING PACK

£499



Roof bars, Roof box 480L

## CYCLE PACK

£400



Roof bars, 2 x bike carriers for roof

## STORAGE PACK

£150

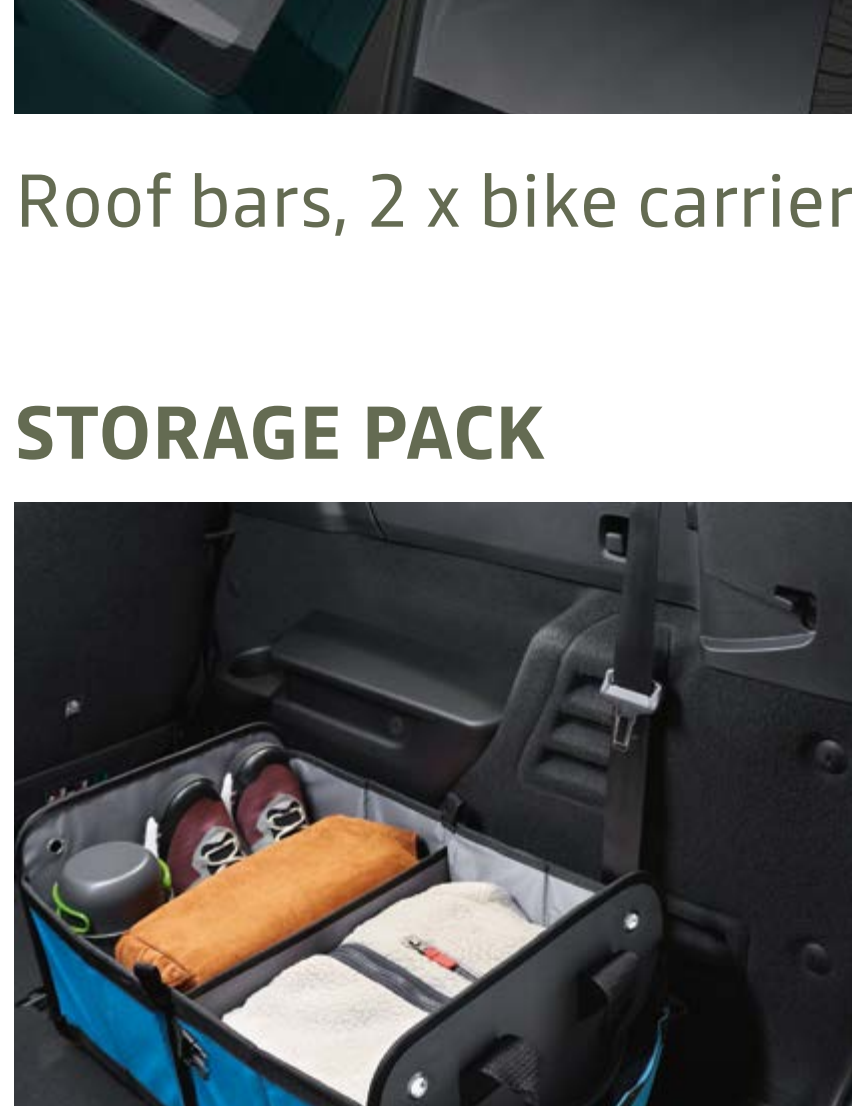

Boot storage box

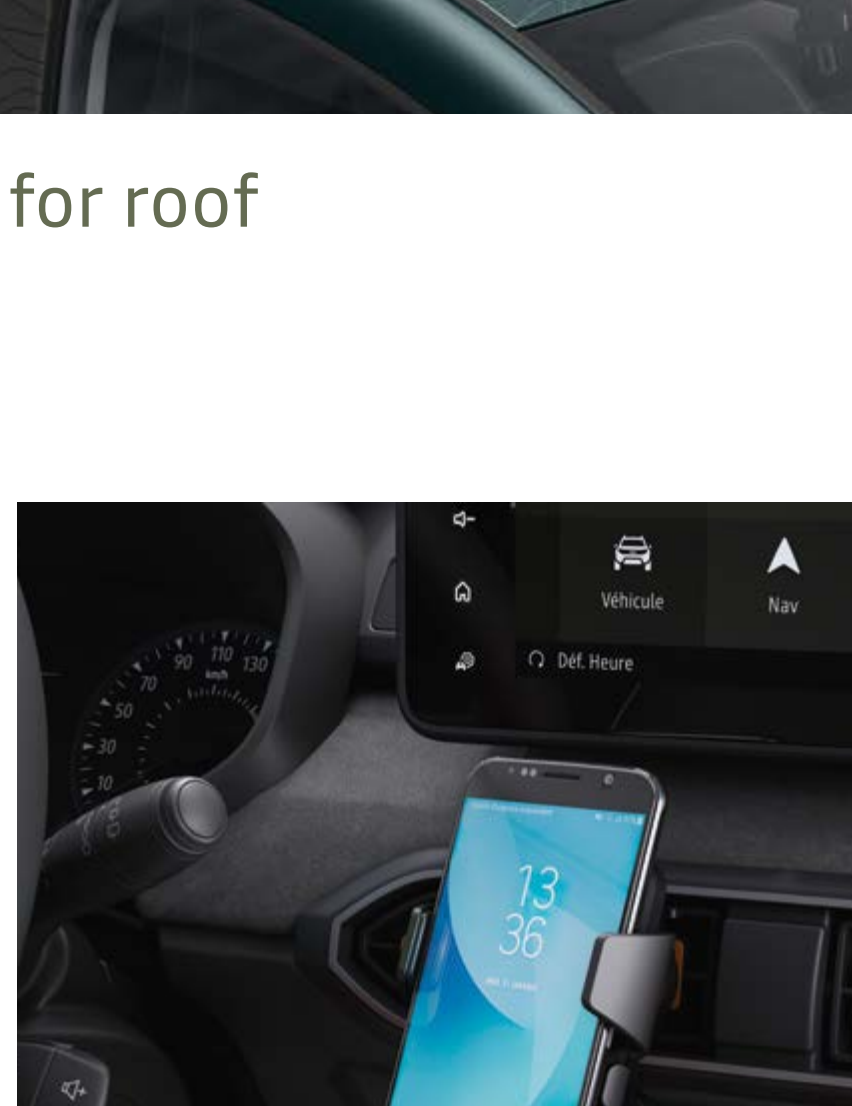

Magnetic phone holder

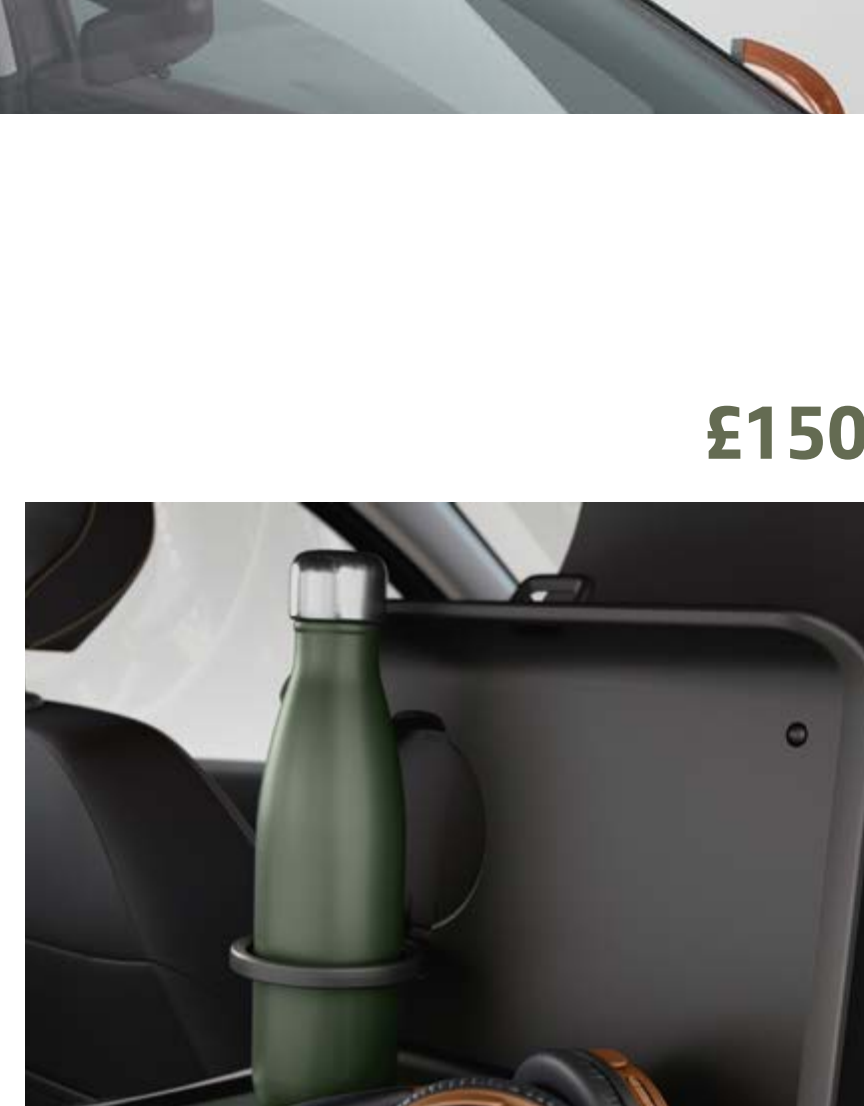

Rear tray table & fixings

Storage pack + available with 2 tray tables & fixings for £252

## TOWBAR PACK

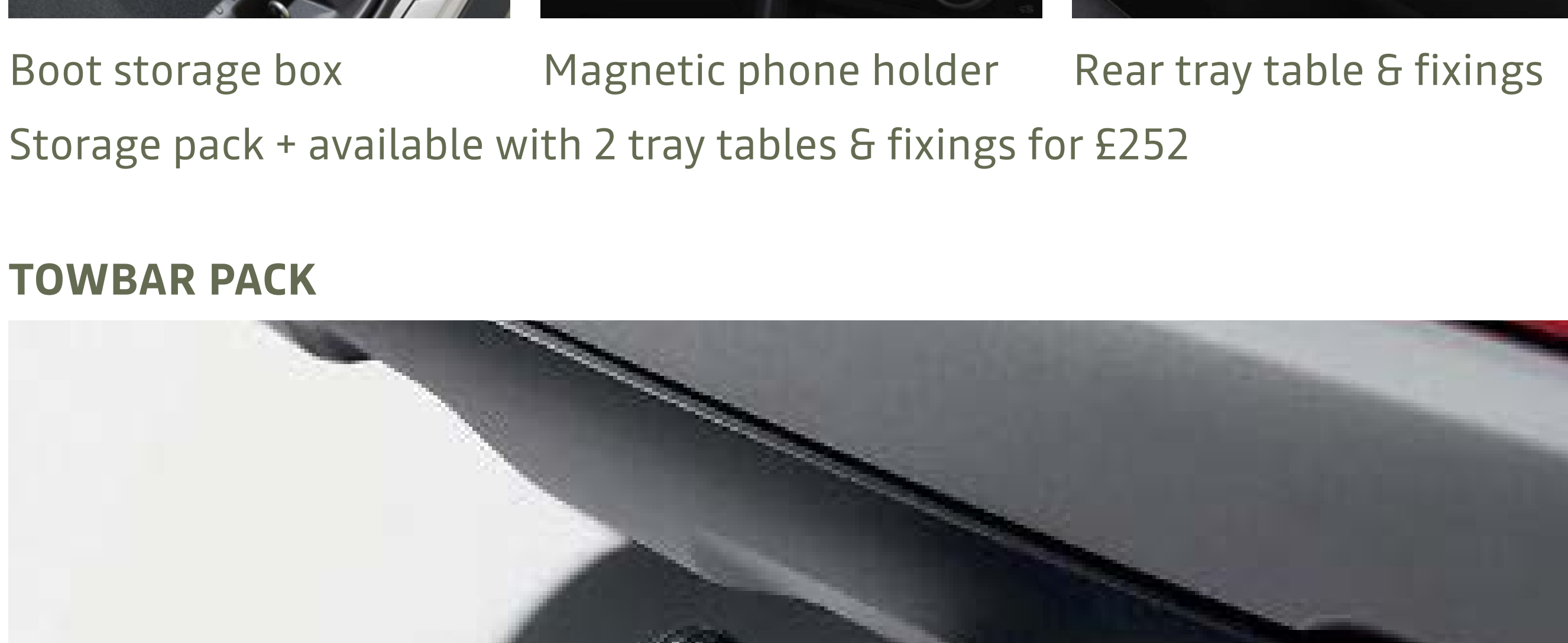

Swan neck towbar 13 pin

Removable towbar 13 pin

£599 inc. fitting

£780 inc. fitting

## PREMIUM DELIVERY PACKS

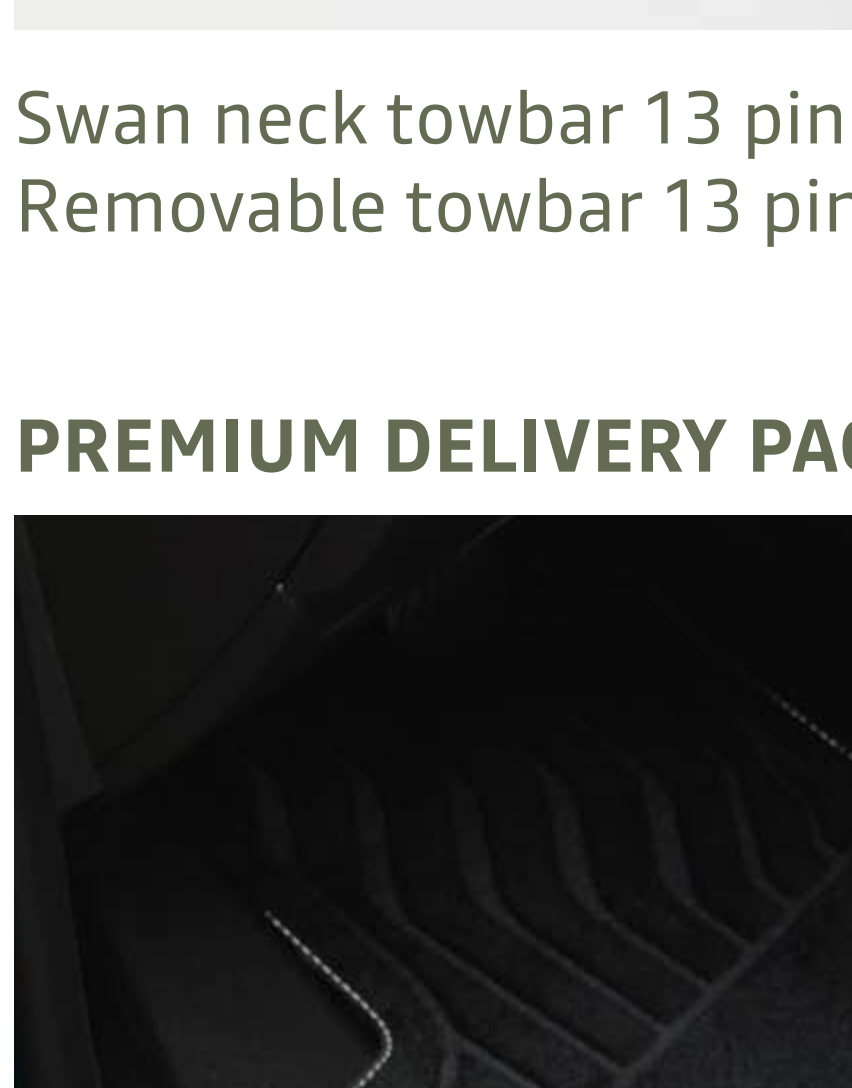

Premium textile floor mats

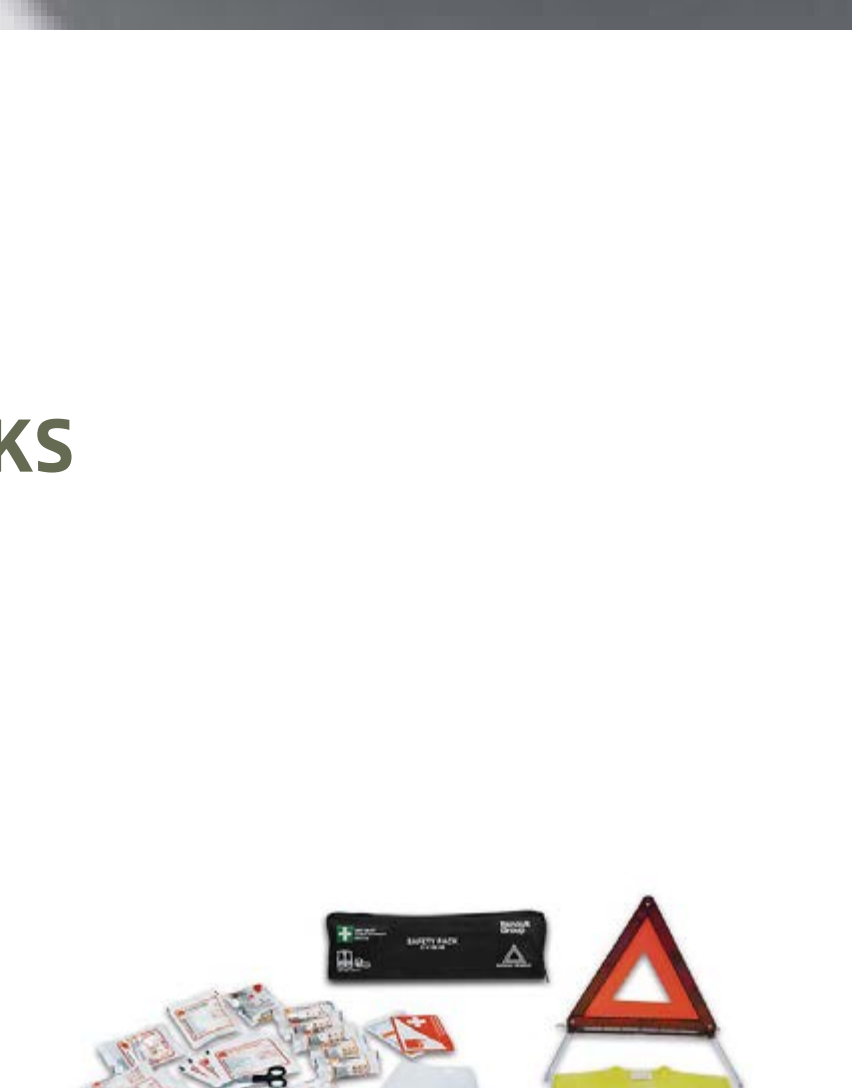

Safety kit

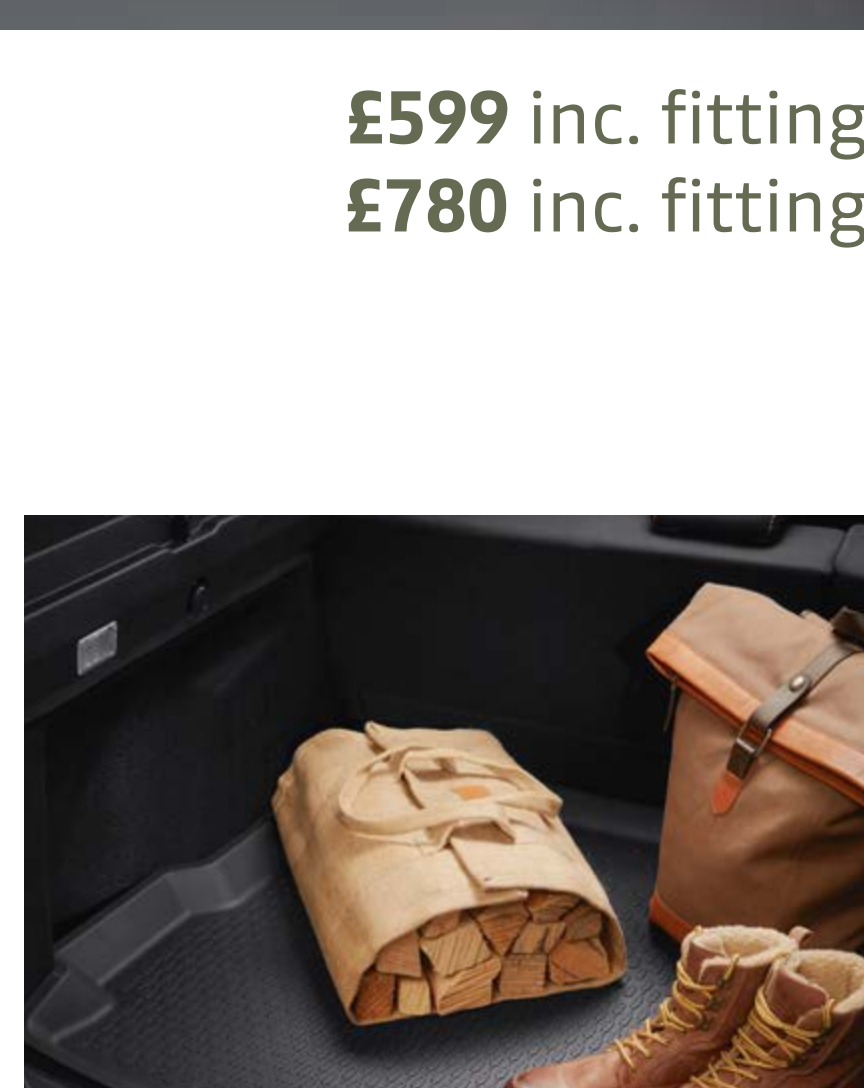

Rubber boot liner 2WD\*

## PREMIUM DELIVERY PACK

£95

Premium textile floor mats

Safety kit

## PREMIUM DELIVERY PACK+

£160

Premium textile floor mats

Safety kit

Rubber boot liner 2WD\*

\*also available on 4WD

All accessories purchased prior to vehicle registration come with a 3 year manufacturers warranty  
Accessories are fitted post production and may have an impact on WLTP fuel (actual) consumption and CO<sub>2</sub> figures

[DOWNLOAD ACCESSORIES BROCHURE](#)



# ENGINES

	TCe 90	TCe 100 Bi-fuel	TCe 130	TCe 150 EDC
<b>ENGINES</b>				
Fuel	Petrol	Petrol + LPG	Petrol	Petrol
Fiscal rating (CV)	5	5	7	8
Max. power kW EEC (hp) at an engine speed of (rpm)	67 (90 hp) at 4,400-4,900	67/74 (90 hp/100 hp) at 4,400-4,900/4,600-5,000	96 (130 hp) at 4,500-6,000	110 (150 hp) at 5,250-6,000
Max torque Nm EEC (m.kg) at an engine speed of (rpm)	160 at 2,200-3,750	160/170 at 2,200-3,750/2,000-3,500	240 at 1,600/3,500	250 at 1,700-3,250
Injection type	Sequential multipoint	Sequential multipoint	Direct injection	Direct injection
Capacity (cc)	999	999	1,332	1,332
No. of cylinders/valves	3 cylinders/12 valves	3 cylinders/12 valves	4 cylinders/16 valves	4 cylinders/16 valves
Emission control standard	Euro 6	Euro 6	Euro 6	Euro 6
Particle filter <sup>(1)</sup>	Yes	Yes	Yes	Yes
Stop & Start <sup>(2)</sup>	Yes	Yes	Yes	Yes

<b>PERFORMANCE</b>				
Top speed (mph) / 0-62 mph (s)	103/13.1	104/13.8	108/10.6	108/9.7
1,000 m from standing start (s)	35.4	36.2	31.6	31.4

<b>GEARBOX AND TRANSMISSION</b>				
Transmission	4x2	4x2	4x2	4x2
Gearbox type / Number of gears	Manual/6	Manual/6	Manual/6	Automatic/6

<b>STEERING</b>				
Steering	Electrical power-assisted steering			
Turning circle, kerb to kerb (m)	10.72	10.72	10.72	10.72

<b>BRAKING</b>				
Front: ventilated disc (VD)/diameter (mm)	(VD)/280	(VD)/280	(VD)/280	(VD)/280
Rear: drum (D)/diameter (inches)	(D)/9	(D)/9	(D)/9	(D)/9

<b>WHEELS AND TYRES</b>				
Reference tyre sizes	215/65 R16 & 215/60 R17			

<b>FUEL CONSUMPTION AND EMISSIONS<sup>(3)</sup></b>				
Approval protocol	WLTP <sup>(4)</sup>			
Eco mode	Yes	Yes	Yes	Yes
Fuel tank capacity (L)	50	Petrol: 50 - LPG <sup>(3)</sup> : 48.8	50	50
AdBlue <sup>®</sup> tank capacity <sup>(4)</sup> (l)	-	-	-	-
CO <sub>2</sub> emissions (g/km)	140	Petrol: 145 / LPG: 127	141	142
Consumption over a combined cycle (mpg)	45.6	Petrol: 44.1 / LPG: 40.4-40.9	45.6	44.8
Consumption over a low cycle (mpg)	38.2	Petrol: 36.7 / LPG: 30.0	38.7	36.7
Consumption over a medium cycle (mpg)	50.4	Petrol: 47.9 / LPG: 42.8-43.5	49.6	47.9
Consumption over a high cycle (mpg)	52.3	Petrol: 50.4-51.4 / LPG: 47.1-48.7	52.3	52.3
Consumption over an extra high cycle (mpg)	41.5	Petrol: 40.4-40.9 / LPG: 39.2-40.4	41.5	42.2

<b>WEIGHT (kg) AND VOLUME</b>				
Max. unladen kerb weight	1,189	1,289	1,242	1,263
Gross train weight (GTW)	2,934	2,960	2,967	2,978
Maximum permissible laden weight (MPLW)	1,734	1,760	1,767	1,778
Max./min. payload <sup>(5)</sup>	460/545	460/478	460/525	450/515
Max. braked towing weight	1,200	1,100	1,200	1,200
Max. unbraked towing weight	630	665	655	665
Min. boot volume under luggage space cover with repair kit /with spare wheel <sup>(6)</sup> (dm <sup>3</sup> VDA)	445/445	445/445	445/445	445/445
Max. boot volume with rear bench seat folded down with repair kit/with spare wheel <sup>(6)</sup> (dm <sup>3</sup> VDA)	1,478/1,478	1,478/1,478	1,478/1,478	1,478/1,478
Min. boot volume under luggage space cover with repair kit/with spare wheel (litres)	478/478	478/478	478/478	478/478
Max. boot volume with rear bench seat folded down with repair kit/with spare wheel (litres)	1,623/1,623	1,623/1,623	1,623/1,623	1,623/1,623

[BUILD YOURS](#)

[MENU](#)



# ENGINES

Blue dCi 115

Blue dCi 115 4WD

ENGINES		
Fuel	Diesel	Diesel
Fiscal rating (hp)	6	6
Max. power kW EEC (hp) at an engine speed of (rpm)	85 (115 hp) at 3,750	84 (115 hp) at 3,750
Max torque Nm EEC (m.kg) at an engine speed of (rpm)	260 at 1,750-2,750	260 at 1,750-2,750
Injection type	Direct injection	Direct injection
Capacity (cc)	1,461	1461
No. of cylinders/valves	4 cylinders/8 valves	4 cylinders/8 valves
Emission control standard	Euro 6	Euro 6
Particle filter <sup>(1)</sup>	Yes	Yes
Stop & Start <sup>(2)</sup>	Yes	Yes

PERFORMANCE		
Top speed (mph) / 0-62 mph (s)	108/10.2	108/10.2
1,000 m from standing start (s)	32.2	33.2

GEARBOX AND TRANSMISSION		
Transmission	4x2	4x4
Gearbox type / Number of gears	Manual/6	Manual/6

STEERING		
Steering	Electrical power-assisted steering	Electrical power-assisted steering
Turning circle, kerb to kerb (m)	10.72	10.72

BRAKING		
Front: ventilated disc (VD)/ diameter (mm)	(VD)/280	(VD)/280
Rear: drum (D)/diameter (inches)	(D)/9	(D)/9

WHEELS AND TYRES		
Reference tyre sizes		

FUEL CONSUMPTION AND EMISSIONS <sup>(3)</sup>		
Approval protocol		
Eco mode	Yes	Yes
Fuel tank capacity (L)	50	50
AdBlue <sup>®</sup> tank capacity <sup>(4)</sup> (l)	15.1	15.1
CO <sub>2</sub> emissions (g/km)	127	141
Consumption over a combined cycle (mpg)	58.9	53.3
Consumption over a low cycle (mpg)	54.3	57.9
Consumption over a medium cycle (mpg)	61.4	56.5
Consumption over a high cycle (mpg)	67.3	61.4
Consumption over an extra high cycle (mpg)	51.4	57.9

WEIGHT (kg) AND VOLUME		
Max. unladen kerb weight	1,350	1,439
Gross train weight (GTW)	2,998	3,445
Maximum permissible laden weight (MPLW)	1,798	1,945
Max./min. payload <sup>(5)</sup>	460/490	460/513
Max. braked towing weight	1,200	1,500
Max. unbraked towing weight	690	740
Min. boot volume under luggage space cover with repair kit /with spare wheel <sup>(6)</sup> (dm <sup>3</sup> VDA)	471/428	411/376
Max. boot volume with rear bench seat folded down with repair kit/ with spare wheel <sup>(6)</sup> (dm <sup>3</sup> VDA)	1,504/1,461	1,444/1,409
Min. boot volume under luggage space cover with repair kit/with spare wheel (litres)	494/471	467/414
Max. boot volume with rear bench seat folded down with repair kit/ with spare wheel (litres)	1,574/1,551	1,614/1,559

(1) Petrol engines with particle filter (DPF): to reduce particle emissions, the new direct injection petrol engines now include a particle filter in the exhaust line. The filter removes particles in the exhaust gases, then burns them using automatic and very regular regeneration. The particle filter requires no maintenance. (2) The vehicle's starter and battery are adjusted for use with the Stop & Start system. (3) Official consumption and emissions according to applicable regulations. (4) Blue dCi Diesel engines: to reduce pollutant emissions, the new Blue dCi Diesel engines are equipped with a selective catalytic reduction device (SCR\*) operating with AdBlue<sup>®</sup> (a non-toxic solution, available at most service stations). This technology converts the nitrogen oxides from Diesel engines into harmless gases. Your vehicle reminds you when it is time to refill the AdBlue<sup>®</sup> tank. \*Selective catalytic reduction involves injecting ammonia (NH<sub>3</sub>) from the AdBlue<sup>®</sup> into the exhaust catalytic converter. The resulting chemical reaction transforms nitrogen oxides (NOx) into non-polluting gases (water vapour and harmless nitrogen). Actual fuel and AdBlue<sup>®</sup> consumption depends on vehicle use, equipment, the user's driving style and the load. (4) WLTP (Worldwide Harmonized Light Vehicle Test Procedures): this new protocol provides results much closer to those found in daily use compared to the NEDC protocol. Fuel consumption and CO<sub>2</sub> emissions are certified using a standard, regulated method. It is identical for all manufacturers and allows vehicles to be compared. (5) The payload indicated is for the lowest equipment level. (6) According to ISO standard 3832.

[BUILD YOURS](#)

[MENU](#)



# EQUIPMENT AND OPTIONS

	ESSENTIAL	EXPRESSION	JOURNEY	EXTREME
<b>EXTERNAL APPEARANCE</b>				
LED brand light	•	•	•	•
Automatic activation of daytime running lights	•	•	•	•
Grille with white hubcaps	•	•	•	•
Front and rear skid plates	Black	Black	Megalith Grey	Megalith Grey
Exterior door handles	Black	Body-coloured	Body-coloured	Body-coloured
Door mirrors	Black	Silver	Megalith Grey	Copper Brown
Roof bars	Black	Black	-	-
Modular roof bars	-	-	Megalith Grey	Megalith Grey
Tinted windows (rear, quarter panels, tailgate)	-	-	•	•
Metallic black shark fin antenna	-	-	-	•
Wing trims in black plastic	-	-	-	•
16" steel wheels	•	-	-	-
16" Oraga alloy wheels	-	•	-	-
17" Tergan alloy wheels	-	-	•	Black
<b>SEATS AND INTERIOR TRIMS</b>				
Air vent surrounds	Steel Grey	Steel Grey	Steel Grey	Copper Brown
Interior door handles	Black	Steel Grey	Steel Grey	Steel Grey
Front door pull handles	-	-	Fig Grey	Fig Grey
1/3- 2/3 split-fold rear bench seatback	•	•	•	•
Soft feel steering wheel	•	•	•	•
Special Essential upholstery	•	-	-	-
Special Expression upholstery	-	•	-	-
Special Journey upholstery	-	-	•	-
Special Extreme upholstery	-	-	-	•
<b>ACTIVE AND PASSIVE SAFETY</b>				
ABS (Anti-lock Braking System) + EBA (Emergency Brake Assist)	•	•	•	•
Electronic Stability Control (ESC) <sup>(1)</sup> with Hill Start Assist (HSA)	•	•	•	•
Driver's front airbag	•	•	•	•
Passenger's front airbag, disconnectable	•	•	•	•
Shoulder and curtain side airbags	•	•	•	•
Front and rear seat belts with pyrotechnic pretensioner	•	•	•	•
Tyre pressure detection	•	•	•	•
3 <sup>rd</sup> 3-point rear seat belt (inertia reel)	•	•	•	•
Blind spot warning	-	-	•	•
Spare wheel + jack <sup>(2)</sup> (except ECO-G version)	o/o	o/o	o/o	o/o
Tyre inflation kit	•	•	•	•
Isofix child seat mounting system on rear side seats	•	•	•	•
180 kmh / 112 mph Speed limiter	•	•	•	•
<b>DRIVING AND CONTROL INSTRUMENTS</b>				
Electrical power-assisted steering	•	•	•	•
On-board computer with 11 functions (LCD screen): overall totaliser, partial totaliser, fuel used, average fuel consumption, predicted driving range, average speed, service/oil change intervals, gear change indicator, exterior temperature, clock and fuel gauge	•	-	-	-
On-board computer with 13 functions (TFT screen): overall totaliser, partial totaliser, fuel used, average fuel consumption, predicted driving range, average speed, service/oil change intervals, gear change indicator, driving speed, language settings, door open warning light, clock, exterior temperature <sup>(1)</sup>	• (if automatic gearbox or ECO-G)	•	•	•
Visual and audible front seat belt warning	•	•	•	•
Eco Mode (Euro 6) + Stop & Start + gear change indicator	•	•	•	•
Hill Descent Control system (only on 4x4)	•	•	•	•
Cruise control and speed limiter	•	•	•	•
Rear parking sensors	•	•	•	•
Rear view camera	-	•	•	•
Multiview camera	-	-	•	•

•: available as standard; o: available as an option; -: not available. (1) Disconnectable only on 4x4 versions.

(2) The "spare wheel + jack" option replaces the "tyre inflation kit".



# EQUIPMENT AND OPTIONS (CONTINUED)

	ESSENTIAL	EXPRESSION	JOURNEY	EXTREME
<b>VISIBILITY</b>				
Front fog lights	•	•	•	•
Heated rear screen/timed rear screen wiper	•/•	•/•	•/•	•/•
Door mirrors with interior manual adjustment	•	-	-	-
Heated electric door mirrors	-	•	•	•
Automatic windscreen wipers	-	-	•	•
<b>COMFORT</b>				
4-speed heating and ventilation with air recirculation	•	-	-	-
Manual heating and air conditioning system	•	•	-	-
Automatic heating and air conditioning system	-	-	•	•
Automatic folding door mirrors	-	-	•	•
Electric door locking with radio frequency remote	•	•	•	•
Keyless entry	-	-	•	•
Electric front windows	•	•	•	•
Electric rear windows	-	•	•	•
Steering wheel adjustable for height and reach	•	•	•	•
Height-adjustable driver's seat	-	•	•	•
Height-adjustable driver's seat with lumbar adjustment	-	-	•	•
Semi-high centre console with sliding plastic-coated fabric armrest and storage	-	-	•	•
Driver's front reading light with 20-second timer	•	-	-	-
2 front reading lights (driver's with 20-second timer and passenger)	-	•	•	•
1 reading light for rear passengers	-	-	•	•
12V sockets front/rear	•/-	•/•	•/•	•/•
Glovebox lighting	-	-	•	•
Boot lighting	•	•	•	•
Heated front seats	-	-	•	•
<b>AUDIO</b>				
Audio pre-equipment	-	-	-	-
Plug & Music: DAB MP3 radio, USB and jack ports, 4 speakers, Bluetooth® telephone with satellite controls	•	-	-	-
8" Media Display: DAB radio, smartphone mirroring via USB cable, Bluetooth® connection, 4 speakers, 8" touchscreen	-	•	-	-
8" Media NAV: MAP CARE navigation (Western or Eastern Europe map + 6 free updates for 3 years), DAB radio, smartphone replication via USB cable, Bluetooth® connection, 6 speakers, 8" touch screen	-	○	•	•
<b>PACKS</b>				
Navigation Pack: rear view camera, Media NAV with MAP CARE navigation (Western or Eastern Europe map + 6 free updates for 3 years) and smartphone replication via USB cable	-	○	•	•
Comfort+ Pack: half-height centre console with sliding armrest and storage, 2 USB ports in the rear, driver's seat with lumbar adjustment	-	-	-	•
Techno Pack: keyless entry, two USB ports in the rear	-	-	○	•

•: available as standard; ○: available as an option; -: not available. (1) Disconnectable only on 4x4 versions. (2) The "spare wheel + jack" option replaces the "tyre inflation kit".

[BUILD YOURS](#)

[MENU](#)



# PRICING

	CO <sub>2</sub> G/KM WLTP	FUEL TYPE	COMBINED FUEL CONSUMPTION (MPG) - WLTP	BHP	BENEFIT IN KIND	VED YEAR 1	BASIC PRICE	VAT 20%	TOTAL RETAIL PRICE	ON THE ROAD PRICE*
<b>ESSENTIAL</b>										
TCe 90 4x2 MY23.5	139	Petrol	45.6 (6.2)	90	32%	£255	£13,658.33	£2,731.67	£16,390.00	£17,295
TCe 100 Bi-Fuel 4x2 MY23.5	145 (Petrol)/127(LPG)	Petrol	44.1 (6.4) & 36.2 (7.8)	100	33%	£245	£13,666.67	£2,733.33	£16,400.00	£17,295
<b>EXPRESSION</b>										
TCe 90 4x2 MY23.5	140	Petrol	45.6 (6.2)	90	33%	£255	£14,491.67	£2,898.33	£17,390.00	£18,295
100 Bi-Fuel 4x2 MY23.5	145 (Petrol)/127(LPG)	Petrol/LPG	44.1 (6.4) & 36.2 (7.8)	100	34%	£245	£14,500.00	£2,900.00	£17,400.00	£18,295
TCe 130 4x2 MY23.5	141	Petrol	45.6 (6.2)	130	33%	£255	£15,658.33	£3,131.67	£18,790.00	£19,695
<b>JOURNEY</b>										
TCe 90 4x2 MY23.5	140	Petrol	45.6 (6.2)	90	33%	£255	£15,741.67	£3,148.33	£18,890.00	£19,795
TCe 100 Bi-Fuel 4x2 MY23.5	145 (Petrol)/127(LPG)	Petrol/LPG	44.1 (6.4) & 36.2 (7.8)	100	34%	£245	£15,750.00	£3,150.00	£18,900.00	£19,795
TCe 130 4x2 MY23.5	141	Petrol	45.6 (6.2)	130	33%	£255	£16,908.33	£3,381.67	£20,290.00	£21,195
TCe 150 4x2 EDC MY23.5	141	Petrol	45.6 (6.2)	150	33%	£255	£18,575.00	£3,715.00	£22,290.00	£23,195
<b>EXTREME</b>										
TCe 100 Bi-Fuel MY23.5	145 (Petrol)/127(LPG)	Petrol/LPG	44.1 (6.4) & 35.8 (7.9)	100	34%	£245	£16,166.67	£3,233.33	£19,400.00	£20,295
TCe 130 4x2 MY23.5	141	Petrol	45.6 (6.2)	130	33%	£255	£17,325.00	£3,465.00	£20,790.00	£21,695
TCe 150 4x2 EDC MY23.5	141	Petrol	45.6 (6.2)	150	33%	£255	£18,991.67	£3,798.33	£22,790.00	£23,695
Blue dCi 115 4x2 MY23.5	126	Diesel	58.9 (4.8)	115	30%	£210	£17,737.50	£3,547.50	£21,285.00	£22,145
Blue dCi 115 4x4 MY23.5	141	Diesel	52.3 (5.4)	115	33%	£255	£19,616.67	£3,923.33	£23,540.00	£24,445

\* "On the Road" price includes delivery to the dealer premises, number plates, 12 months government road fund license (depending on CO<sub>2</sub> emissions) and First Registration Fee at £55.

# OPTIONS

	ESSENTIAL	EXPRESSION	JOURNEY	BASIC PRICE	VAT 20%	TOTAL RETAIL PRICE
Metallic & opaque paint	○	○	○	£541.67	£108.33	£650
Spare Wheel (excluding Bi-Fuel)	○	○	○	£250.00	£50.00	£300



# WE'VE GOT YOU COVERED

You might think our shockingly affordable prices mean our cars aren't made to last. Actually, the Dacia range is one tough cookie. To prove it, you get a 3-year\* warranty (or 60,000 miles, if you reach that first). This means we will replace any part which has been deemed by a Dacia approved dealer to be defective due to a manufacturing fault, free of charge. To keep the good times rolling, you can extend your warranty up to 7 years for a great price. We also give you a 2-year paintwork and 6-year anti-corrosion warranty, so you can kick back knowing that your Dacia will stay looking good-as-new for years to come.

## ROADSIDE ASSISTANCE

Although our cars are built for plain sailing, you can rely on us if you have a breakdown – 24/7 365, wherever you are in the UK or Northern Ireland. This offer also stands for the first 3 years/60,000 miles $\Delta$  after you buy your new Dacia.

## DACIA CAR INSURANCE 1

Dacia Insurance has been specifically created to provide superb protection for you and your car. Unlike most other UK insurers, in the event of an accident, your Dacia will be repaired at a Dacia Approved Bodyshop using only Dacia approved parts and approved repair methods. This maintains your Dacia's safety rating, protects its resale value and helps to maintain its Dacia warranty $\wedge$ . Dacia Insurance also offers a courtesy car for the duration of a repair at a Dacia Approved Bodyshop.

**Dacia car insurance: 0330 102 7795 [www.daciacarinsurance.co.uk](http://www.daciacarinsurance.co.uk)**

Lines are open Mon - Thurs 8.30am - 7pm, Fri 9am - 6pm, Sat 9am - 5pm

## SERVICING

Dacia Service Plans are the ultimate hassle free way to take care of your vehicle. Depending on the Service plan you purchase (see opposite grid) your servicing needs are covered and you benefit from;

- Inflation Proof Servicing – You know exactly what you'll pay and there are no hidden costs
- Peace of Mind – No matter where life takes you, we'll be there in over 5000 workshops across Europe
- Dacia Expertise & Quality – Our highly trained technicians know your Dacia inside out

The Dacia Service Plan contains Dacia services in-line with the manufacturer's service schedule, plus comes with a complimentary vehicle health check to ensure your Dacia is in the best condition possible.

SERVICE PLAN $\wedge$	Cash Price	Monthly payments with Dacia Finance $\ast\ast$
2 years / 20,000 miles Service Plan	-	£9.99 per month
3 years / 30,000 miles Service Plan	£576	£12.99 per month
4 years / 40,000 miles Service Plan + 1 MOT	£1,056	£16.99 per month
<b>SERVICING<math>\wedge</math> + EXTENDED WARRANTY PLAN + 1 MOT</b>		
4 years / 60,000 miles	£1,464	£17.99 per month

EXTENDED WARRANTY	Total Retail Price
4 years / 60,000 miles $\dagger$	£165
5 years / 60,000 miles $\dagger$	£275
6 years / 60,000 miles $\dagger$	£415
4 years / 100,000 miles $\dagger$	£490
5 years / 100,000 miles $\dagger$	£565
6 years / 100,000 miles $\dagger$	£715

Dacia Extended warranty ends when you reach the age or mileage limit (whichever comes first). For full Warranty Terms and Conditions visit [www.dacia.co.uk/warranty-and-assistance/assistance](http://www.dacia.co.uk/warranty-and-assistance/assistance)

## SERVICE INTERVALS $\diamond$

Annual servicing **OR** servicing at 18,000 miles (whichever comes first)

Service Schedule $\diamond$	Year 1	Year 2	Year 3	Year 4	Year 5	Year 6
	Cabin filter change	Oil change + Cabin filter change	Cabin filter change + Brake fluid change	Oil change + Cabin filter change + Brake fluid change	Cabin filter change + Coolant 150km change	Cabin filter change + Belts 150km change

\*Dacia warranty ends when you reach the age or mileage limit (whichever comes first), from date of registration. Subject to status, terms and conditions apply. For full Dacia Extended Warranty Terms and Conditions visit [www.dacia.co.uk/warranty-and-assistance/warranty](http://www.dacia.co.uk/warranty-and-assistance/warranty)

$\Delta$ Roadside assistance for the first 3 year / 60,000 miles, which ever is reached first, from date of registration. For full Terms and Conditions visit [www.dacia.co.uk/warranty-and-assistance/assistance](http://www.dacia.co.uk/warranty-and-assistance/assistance)

$\dagger$  Dacia Extended warranties are available to purchase from first date of registration up to end of manufacturer warranty. For full Dacia Extended Warranty Terms and Conditions visit [www.dacia.co.uk/warranty-and-assistance/warranty](http://www.dacia.co.uk/warranty-and-assistance/warranty)

The monthly service plan offer is available at point of signing an agreement for vehicle purchased under HP and PCP finance agreement provided by Dacia Finance Ltd. (Not available on cash purchases).

$\wedge$  The Service plan offer is available for eligible retail vehicles only and valid at participating dealers only. Vehicles must be ordered between 3 October to 3 January and registered by 31 March 2024. The Dacia Service plan covers the manufacturer's minimum maintenance programme requirements for the term of the Service plan purchased (refer to the Warranty and Service sheet in the Handover Document wallet for details). The plan ends when you reach the age or mileage limit (whichever comes first). Services must be carried out in line with the manufacturer's minimum maintenance programme requirements and servicing intervals within +/- 1 month or 1,000 miles of the service interval and can only be carried out at a Dacia Approved outlet. Service plans do not cover wear and tear items such as (but not limited to) tyres, wiper blades or brakes. For Service plan full Terms & Conditions visit [www.dacia.co.uk/services-and-finance/service-plan](http://www.dacia.co.uk/services-and-finance/service-plan). Cannot be part exchanged, refunded or transferred.

$\diamond$  The service schedule and intervals are subject to the registration number. Ask your local dealer to confirm your service schedule / intervals as the above is a guideline.

$\ast\ast$ 36 or 48 monthly payments options are only available at point of signing a finance agreement provided by Dacia Finance, Rivers Office Park, Denham Way, Rickmansworth, WD3 9YS. Guarantees and indemnities may be required. You must be a UK resident (excluding the Channel Islands) and over 18 to apply for finance. Terms and conditions apply.

1 Dacia Insurance is arranged and administered by Verex Insurance Services Ltd, which is registered in England and Wales No. 05686831 at Batchworth House, Church Street, Rickmansworth, Herts, WD3 1JE and authorised and regulated by the Financial Conduct Authority, No. 487185. Verex Insurance Services Ltd arranges policies from a panel of insurers, details are available on request.

$\wedge$ If your insurer uses non-approved parts which subsequently fail, they may not be covered under your manufacturer's warranty.



# DIMENSIONS

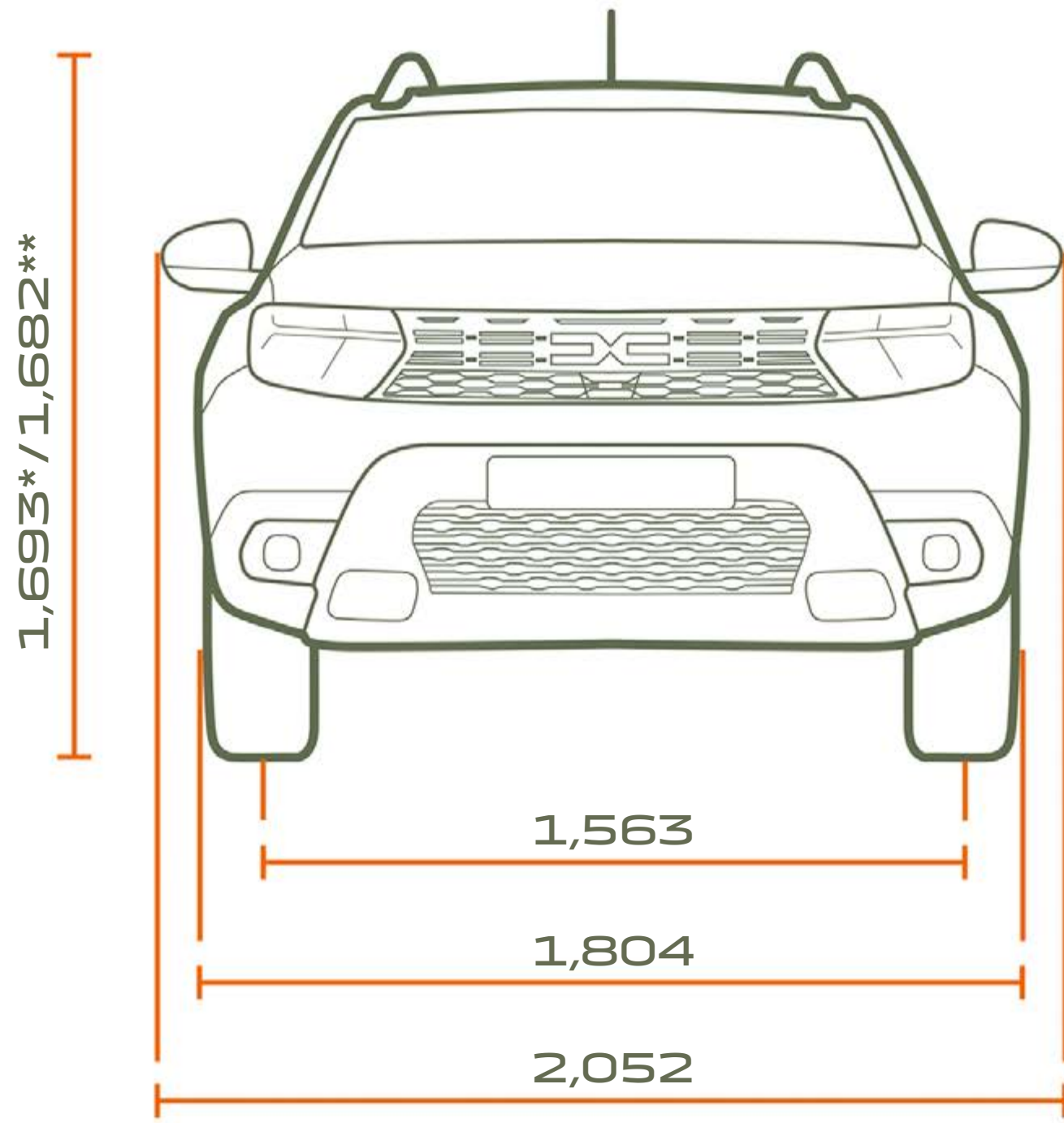

**FRONT VIEW**

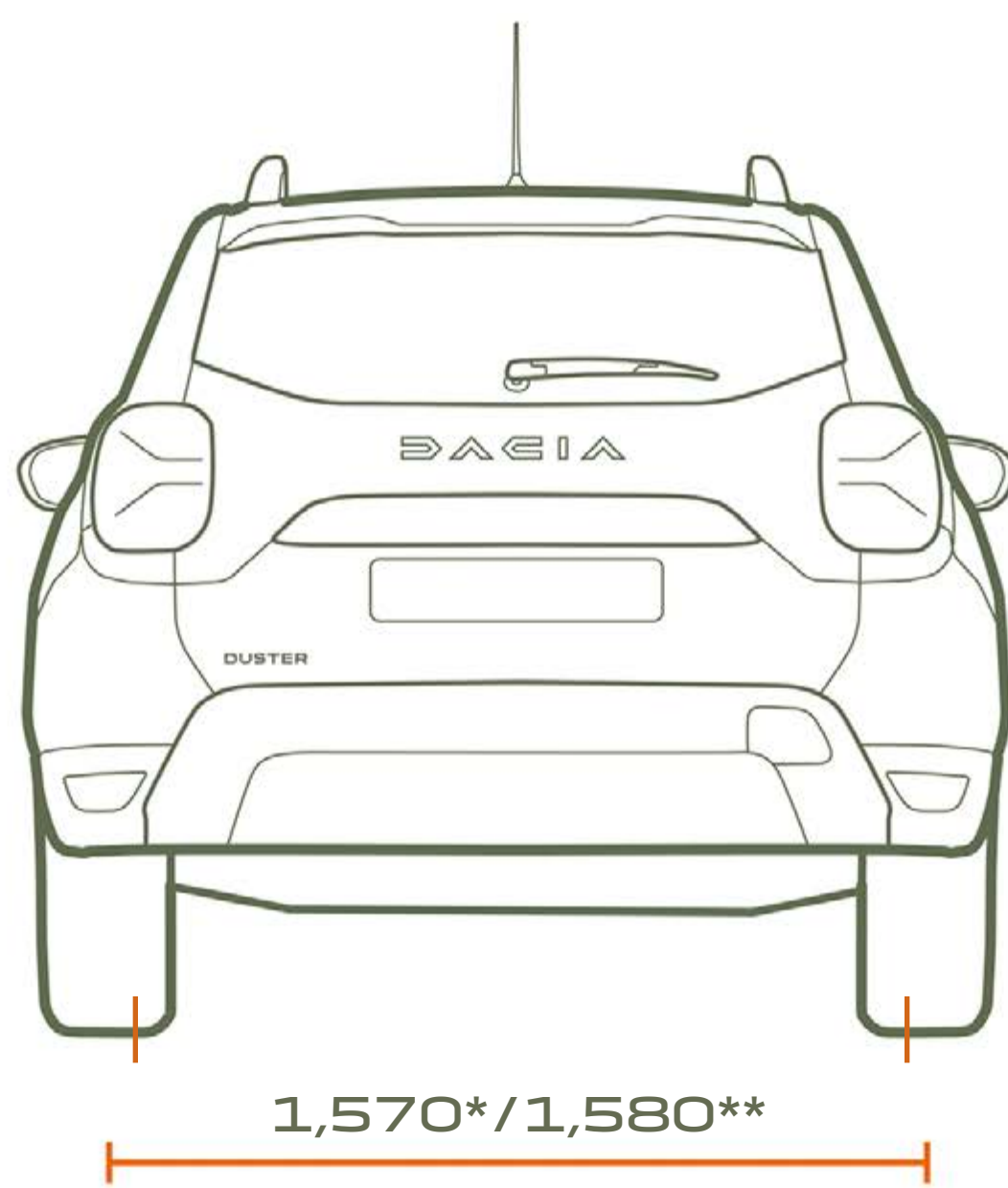

**REAR VIEW**

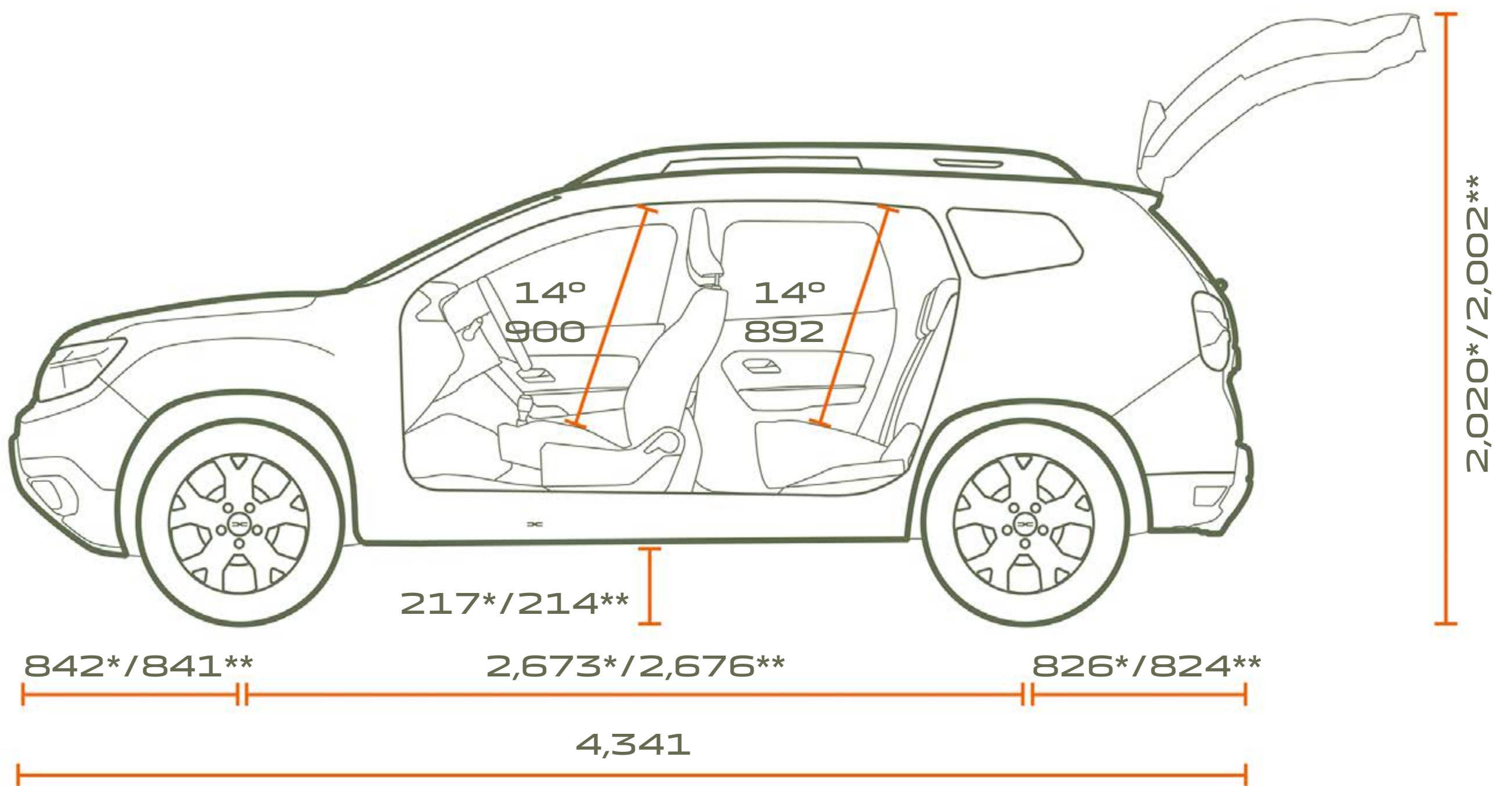

**PROFILE VIEW**

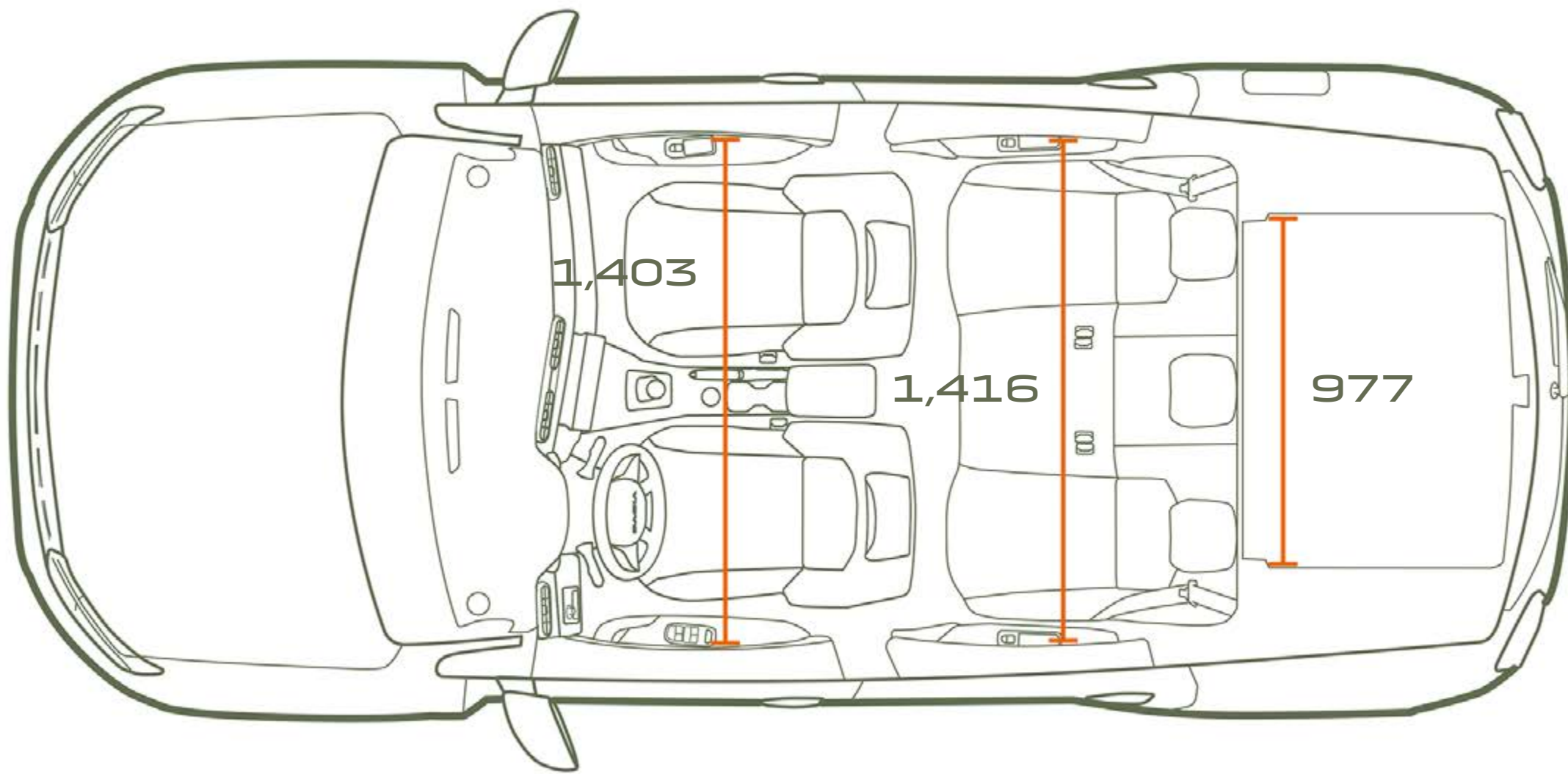

**TOP VIEW**

**BOOT (L)**

Min. boot volume under luggage space cover with spare wheel (4x2/4x4)	478/414
Max. boot volume with rear bench seat folded down with spare wheel (4x2/4x4)	1,623/1,559

Dimension in mm.  
 \*Version 4x2.  
 \*\*Version 4x4



# AN INCREDIBLE SUCCESS STORY

At Dacia, we offer practical and robust vehicles at the best price. Our models have a distinctive style without unnecessary frills, equipped with the most reliable and approved technologies, all at an unbeatable price. In just fifteen years, we have changed the game and disrupted the automotive market.





# TO GO FURTHER

[CLICK AND CONFIGURE](#)

[BOOK A TEST DRIVE](#)

[FIND YOUR DEALERSHIP](#)



Access the DACIA  
Facebook account



Access the DACIA  
Twitter account

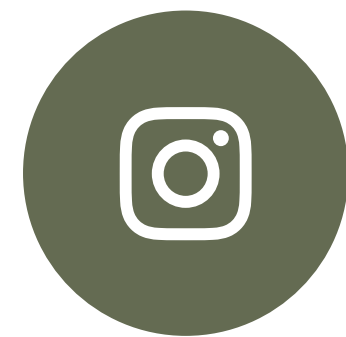

Access the DACIA  
Instagram account

The contents of this brochure were accurate and up-to-date at the time of publication. This document was produced based on pre-series or prototype vehicles. As part of its policy of continuous product improvement, Dacia reserves the right, at any time, to make changes to the specifications and vehicles and accessories described and illustrated. These modifications are notified to Dacia dealers as soon as possible. Depending on the country of sale, versions may differ, and some equipment may not be available (as standard, optional, or accessory). Please consult your Dacia representative for the most up-to-date information. Due to the limitations of printing, the colors shown in this document may slightly differ from the actual paint colors or interior trim materials. All rights reserved. Reproduction, in whole or in part, of this brochure in any form or by any means is prohibited without the prior written authorization of Dacia.

Dacia recommends 

PUBLICIS – PHOTO CREDITS: ADDITIVE, BAM, P. CURTET, MARC & DAVID, H. PICARD, ©RENAULT MARKETING 3D-COMMERCE – OCTOBER 2023